

INSTRUCTION MANUAL



Copyright © 1960 by Tektronix, Inc., Portland, Oregon. Printed in the United States of America. All rights reserved. Contents of this publication may not be reproduced in any form without permission of the copyright owner.



INTRODUCTION

This manual is intended for use by persons concerned with both operation and maintenance of a Tektronix Type 1121 wide-band preamplifier. The manual contains complete and detailed information on operation of the instrument, plus applications to which the Type 1121 can be put, full explanation of the circuitry in both amplifier and power supply circuits, and detailed information about maintenance, troubleshooting and re-calibration.

Since it is expected that this manual will be used by maintenance personnel, the information on component replacement, troubleshooting and circuit specifications is in considerably greater detail than is generally found in an operational manual.

Adjustment and calibration procedures found in this manual are closely parallel to those used by our Tektronix calibration engineers in original factory calibration. And if followed closely, these procedures will insure optimum performance from your instrument for a maximum length of time.



WARRANTY

All Tektronix instruments are fully guaranteed against defective materials and workmanship for a period of one year. Should replacement parts be required, whether at no charge under warranty or at established net prices, notify us promptly. You should include the instrument type, serial number, and sufficient details to identify the required parts. We will ship them prepaid (via air if requested) as soon as possible, usually within 24 hours.

Tektronix transformers manufactured in our own plant carry an indefinite warranty.

All price revisions and design modification privileges reserved.

CONTENTS

Introduction

Warranty

Section 1 Specifications

Section 2 Operating Information

Section 3 Theory of Operation

Section 4 Maintenance

Section 5 Internal Adjustments

Section 6 Accessories Catalog



Type 1121

SECTION 1

SPECIFICATIONS

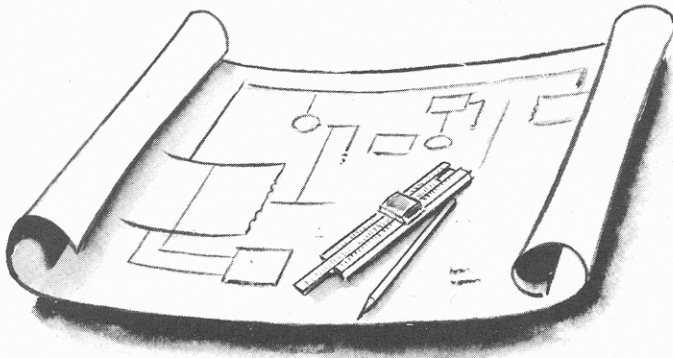

General Information

The Tektronix Type 1121 Amplifier is a self-contained two stage amplifier designed primarily to increase the sensitivity of the equipment with which it is used. Overall gain of the unit is 100. Thus, with maximum input of ± 10 mv, the output is ± 1 v. A cascode-type step attenuator permits attenuation of the input signal from 1X to 500X in nine calibrated steps. This allows a signal of up to ± 5 volts at the input connector without overloading the amplifier. Connection between the Type 1121 and the equipment it is to drive is via a matched 93-ohm coaxial cable, so that the separation of the instruments may be 100 feet or more. As in all Tektronix instruments, primary emphasis has been placed on the achievement of optimum transient response. The pass band of the Type 1121 is in excess of 17 megacycles.

Its compactness and versatility make the Type 1121 well adapted for use with any oscilloscopes or other equipment employing wide-band amplification.

Characteristics

Voltage Gain—100.

Input Impedance, direct, 1 megohm—approximately $22 \mu\text{mf}$.

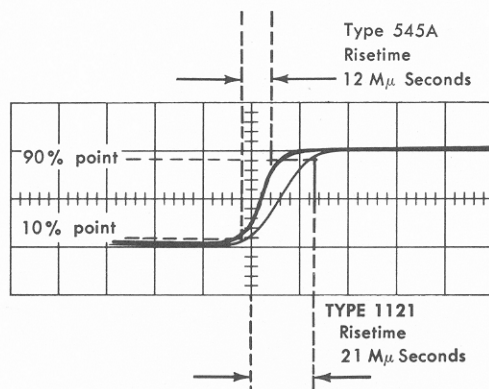

Fig. 1-1. Comparison of vertical risetimes of the Type 1121 and Type 545A Oscilloscope.

Band Pass—5 cps to 17 mc at 1X, 2X, 5X and 10X attenuation, 5 cps to 16.5 mc at 120X, 5 cps to 16.0 mc at 50X, 5 cps to 15.5 mc at 100X and 5 cps to 12.0 mc at 500X.

Maximum Output Voltage—2 volts peak to peak in 93-ohm cable.

Weight—18 pounds.

Finish—Panel, photo-etched aluminum with Black Letters.

Cabinet—Blue wrinkle finish.

Accessories—1 coaxial connecting cable, 93-ohm terminated.

1 Power Cord.

1 Instruction Manual.

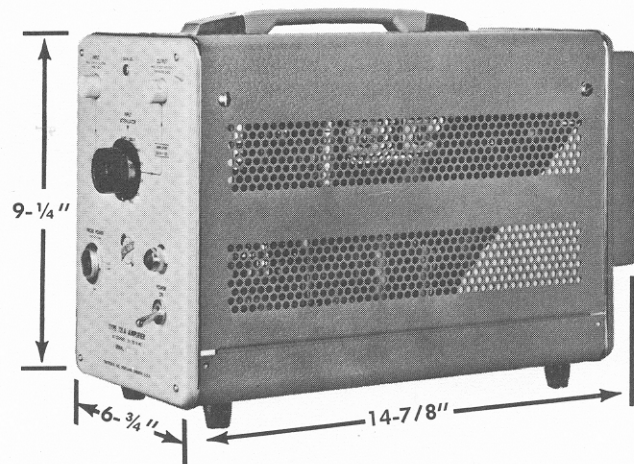
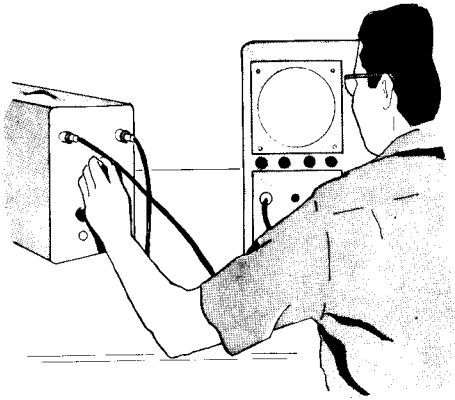

Fig. 1-2. Type 1121 Amplifier Dimensions.



OPERATING INFORMATION

General Information

The Type 1121 can be operated in any normal indoor location, or in the open if protected from moisture. If the instrument has been exposed to dampness, it should be left in a warm room until thoroughly dry before being placed in operation.

The Type 1121 is cooled by an air fan to maintain safe operating temperature in the interior of the instrument. Whenever the instrument is operating, sufficient clearance should be provided at the rear, sides and top for adequate air circulation. If it is used continuously for the same application, with the controls generally set at the same positions, it is advisable to periodically check the instrument at all control settings to be sure that the seldom-used positions are still in normal operating condition. Occasional operation of these control positions also prevents accumulation of dirt and tarnish on the contacts.

Although the components in the Type 1121 are well supported and the adjustments are relatively stable in setting to allow for portable operation, care should be taken not to subject the instrument to unnecessary vibration or rough handling. While shock-mounting of the amplifier chassis gives considerable protection against normal vibration and handling, any additional noise that may be introduced through loosened components, or any additional microphonic characteristics in tubes will greatly detract from operating efficiency of the instrument.

Signal Input Connection

The Type 1121 is designed to present an input impedance of 1 megohm shunted by about $22 \mu\mu\text{f}$, at all sensitivity positions of the turret attenuator. This design feature permits the use of an rc probe to get increased input impedance, and thus reduced loading on the circuit under observation. This increased input impedance will of course be at the expense of some loss in gain. The standard Tektronix Type P6000 Probe as supplied with most Tektronix oscilloscopes may be used with the Type 1121. This probe provides an input impedance of 10 megohms shunted by $10 \mu\mu\text{f}$ with an attenuation of 10X.

Since the input capacitance of the Type 1121 is likely to be different than that of most oscilloscopes it will be used with, the probe must be readjusted before use to give an undistorted waveform. For information on probe adjustment, refer to the appropriate section of your oscilloscope Operator's Manual.

If it is necessary to frequently interchange the probe between the INPUT of the Type 1121 and the oscilloscope, it's a good idea to obtain another probe for use with the Type 1121 to save yourself the trouble of making continuous probe adjustments.

For applications requiring both high impedance input and high gain, where the attenuation of an rc probe would be objectionable, an amplifier or cathode-follower probe can be used. The front panel PROBE POWER socket provides 0.2 amp dc at 6.3 volts for the heater and 10 ma regulated dc at 120 volts for the plate supply of a vacuum-tube probe.

Output Connections

The Type 1121 has a cathode follower output stage to permit connection to the oscilloscope input by means of a terminated coaxial cable. This feature allows a separation of 100 feet or more between the instruments without causing noticeable distortion of the waveform.

A 42-inch Type P93B terminated 93-ohm output cable with UHF connectors is supplied with your Type 1121. In connecting the Type 1121 to an oscilloscope, be sure that the red-painted UHF connector on the interconnecting cable is at the Type 1121 end. If additional length between the Type 1121 and the oscilloscope is needed, insert a section of 93-ohm cable between the unterminated end of the P93B cable and the oscilloscope.

NOTE

The output cable must be properly terminated to prevent reflections and consequent waveform distortion.

Input Attenuation

The Type 1121 is provided with a dependable turret-type step attenuator which permits attenuation of input level all the way from X1 or "straight-through" down to a factor of X500 in nine calibrated steps. This input attenuation feature permits attenuation of the input signal to prevent overloading of the Type 1121. However, it should be remembered that the GAIN of the Type 1121 is not attenuated, and always remains 100 regardless of front-panel settings.

Operating Information — Type 1121

This means that any hum or noise present in the input signal will be amplified 100 times, along with the desirable components of the signal. It is therefore important, in operation of the Type 1121 that whenever the input signal does not exceed the 10 mv limitation of the amplifier, all necessary attenuation be accomplished AFTER the output of the Type 1121 in other words, between the Type 1121 and the oscilloscope or other device being fed from the Type 1121.

Probe Power Output

A Probe Power Output is provided in the Type 1121 for the purpose of supplying voltage for operation of a cathode follower probe or auxiliary preamplifier. The voltage output for the probe supply is fixed at approximately +120 volts.

THEORY OF OPERATION

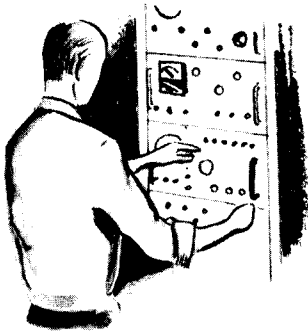

General Information

This portion of the Operator's Manual presents a brief discussion of the Type 1121 Amplifier and Power Supply circuit operation. This discussion is keyed to the Block Diagram and detailed circuit diagrams in the Parts List and Schematic Diagram booklet. Emphasis is placed on interrelation of circuits and general theory of operation rather than on a detailed description of the circuitry.

Amplifier Operation

The amplifier section of the Type 1121 is a two-stage amplifier, giving an output signal of the same polarity as the input. In other words, if a positive-going square wave is inserted through the attenuator to the control grid of V424A, the input amplifier stage, a positive-going square wave will be received at the output connector from the cathode of V483, the Output Cathode Follower. This signal is amplified by a factor of 100.

The triode input circuit, V424A and V424B, is a cascode type using a reliable frame grid tube. This gives a very low input noise level of only about $50 \mu\text{v rms}$, referred to the input with the input grid grounded. Hum pickup at the

input is also considerably reduced by the addition of a turret-type attenuator which allows the use of very short lead lengths. The turret-type attenuator is also very superior at high signal frequencies.

All stages in the Type 1121 amplifier unit make use of "long-tailing" for added gain stability. In other words, cathodes are referenced to a voltage source across resistors of considerable size. The large voltage drop thus achieved between voltage source and cathode maintains current flow through the tube at a nearly constant level, regardless of the type or amplitude of signal impressed on the signal electrode of the tube.

The input stage, V424 is AC coupled to Cathode Follower V443A, which in turn is DC coupled to the grid of V454, a high-gain pentode, comprising the second stage of amplification. The output of V454 is AC coupled to Cathode Follower V443B, which then is DC coupled to a second Cathode Follower, V483. The use of dual Cathode followers effectively eliminates reflected signals from the output, which might otherwise adversely affect the transient response of the amplifier.

Output Cathode Follower V483 is adjusted for an output impedance of 93 ohms. Thus, when a terminated 93 ohm cable is used between output and the instrument to be

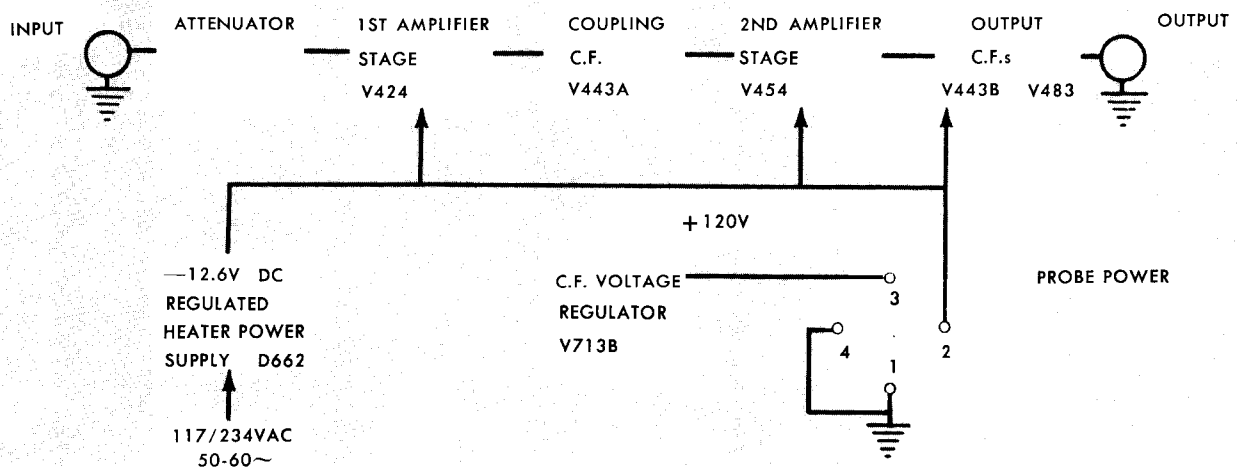

Fig. 3-1. Type 1121 Amplifier Circuit Block Diagram.

Theory of Operation — Type 1121

driven by the Type 1121, it is effectively terminated at both ends. This eliminates any reflections that might occur due to capacitive or inductive loads.

The Type 1121 amplifier circuit is shock-mounted to float freely on rubber mountings. This reduces microphonics to an absolute minimum and contributes further to the exceptional performance of the instrument. Because of the excellent frequency response of the Type 1121 over a band extending from 5 cps to over 16 mc it is extremely satisfactory for use with wide-band oscilloscopes such as the Tektronix Type 541A and 545A series, without adversely affecting their excellent rise-time and bandwidth characteristics.

Power Supply Circuit

Exceptionally good power supply voltage regulation is required for satisfactory operation of the Type 1121 amplifier. This is provided by a power supply offering several regulated voltage levels with extremely low ripple.

The -150 volt supply is used for reference, and is specifically designed for stability and high gain. Ripple voltage

on the -150 volt supply should be less than one-half millivolt, and may be as low as .2 mv.

Circuitry in the $+225$ volt supply is identical with that in the -150 supply, and its ripple component will be less than one-half millivolt, often reading as low as .2 mv.

A voltage setting Cathode Follower provides a $+130$ volt output and also furnishes probe power to the front panel. The probe power source may be used to operate a Cathode Follower probe if desired.

The power supply also provides a $+150$ volt supply for the high current Output Cathode Follower, V483, and for isolation from the other amplifier stages.

A -12.6 volt tube heater supply is provided through the transistor voltage regulator Q654, Q664, Q667. This dc heater supply is designed for extremely low ripple component of less than 2 millivolts.

The Type 1121 is cooled by an air fan whose motor is shock mounted for control of vibration to keep microphonics at a minimum. The motor itself also has a very low external field for elimination of hum.

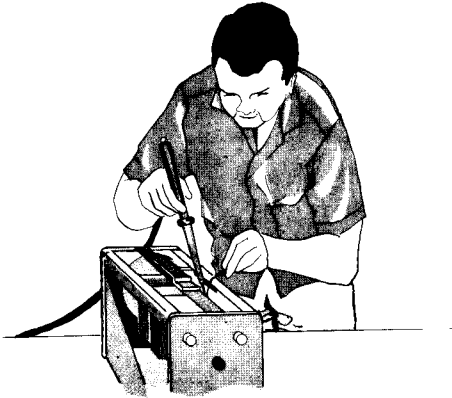

MAINTENANCE

PREVENTIVE MAINTENANCE

Air Filter

The Type 1121 Amplifier is cooled by air drawn into the instrument through a washable filter constructed of adhesive-coated aluminum wool. If the filter becomes dirty, it will restrict the flow of air and may cause the instrument to overheat. You should inspect and clean the filter every three or four months. Any time that the thermal relay in the instrument opens up, the filter should be checked immediately.

To clean the filter, first remove loose dirt from the filter by rapping it gently on a hard surface. Then wash the filter briskly with hot soapy water. After rinsing and drying thoroughly, coat the filter with "Handi-Koter" or "Filtercoat", products of the Research Products Corporation. These pro-

ducts are generally available from air-conditioner suppliers.

Visual Inspection

You should visually inspect the entire Preamplifier every few months for possible circuit defects. These defects may include such things as loose or broken connections, improperly seated tubes, scorched wires or resistors, missing tube shields or broken terminal strips. For most visual troubles the remedy is apparent; however, particular care must be taken when heat-damaged components are detected. Overheating of parts is often the result of other, less apparent, defects in the circuit. It is essential that you determine the cause of overheating before replacing heat damaged parts in order to prevent further damage.

MAINTENANCE

Recalibration

The Type 1121 Amplifier is a stable instrument that will provide many hours of trouble-free operation. However, to insure the faithful reproduction of amplified signals and the excellence of frequency response throughout the band, we suggest that you recalibrate the instrument after each 500

hours of operation (or every six months if used intermittently.) Since this manual is designed for the use of maintenance and repair personnel as well as operators of the Type 1121, a complete calibration procedure, following very closely the procedure used by factory calibration engineers, is given in the Internal Adjustments section of this manual.

REMOVAL AND REPLACEMENT OF PARTS

General Information

Procedures required for replacement of most parts in the Type 1121 Amplifier are obvious. Detailed instructions for their removal are therefore not required. Other parts, however, can best be removed if a definite procedure is followed. Instructions for the removal of some of these parts are contained in the following paragraphs. Because of the nature of the instrument, replacement of certain parts will require that you recalibrate portions of the amplifier to insure proper operation. For calibration procedures, refer to the Internal Adjustments portion of this manual.

Removal of Panels

The panels of the Type 1121 are held in place by small screwhead fasteners. To remove the side panels, use a screwdriver to rotate the fasteners approximately two turns counterclockwise; then pull the upper portion of the panels outward from the carrying handles. To remove the bottom panel, lay the instrument on its side and remove the screws holding the panel in place. Panels are replaced by reversing the order of their removal.

Tube Replacements

Care should be taken both in preventive and corrective maintenance that tubes are not replaced unless they are actually causing a trouble. Many times during routine maintenance it will be necessary for you to remove tubes from their sockets. It is important that these tubes be returned to the same sockets unless they are actually defective. Unnecessary replacement or switching of tubes will many times necessitate recalibration of the instrument. If tubes in your Type 1121 do need replacement, it is extremely desirable that they be replaced by tubes of the same designation and where possible by tubes *from the same manufacturer* as those originally installed in your instrument. This is true because tubes of the same number and letter designation by different manufacturers often vary considerably in characteristics—and in a precision-type preamplifier such as the Type 1121, tubes are carefully selected to meet exacting specifications in Tektronix manufacture or factory calibration.

Soldering Precautions

In the production of Tektronix instruments, a special silver-bearing solder is used to establish a bond to the ceramic terminal strips. This bond can be broken by repeated use of ordinary tin-lead solder, or by the application of too much heat. However, occasional use of ordinary solder will not break the bond if too much heat is not applied.

It is advisable that you have a stock of solder containing about 3% silver if you frequently perform work on Tektronix instruments. This type of solder is used frequently in printed circuitry and should be readily available. It may also be purchased directly from Tektronix in one-pound rolls (order by part number 251-514).

Because of the shape of the terminals on the ceramic terminal strips, it is advisable to use a wedge-shaped tip on your soldering iron when you are installing or removing parts from the strips. A wedge-shaped tip allows you to apply heat directly to the solder in the terminals and reduce the amount of heat required. It is important to use as little heat as possible.

REPLACEMENT PARTS

Standard Parts

Replacement for all parts used in the Type 1121 Wide-Band Preamplifier can be purchased directly from Tektronix at current net prices. However, since most of the components are standard electronic parts, they can generally be obtained locally in less time than is required to obtain them from the factory. Before ordering or purchasing parts, be sure to consult the parts list to determine the tolerances and ratings required. The parts list gives the values, tolerances, and ratings and Tektronix part numbers for all components used in the instrument.

Special Parts

In addition to the standard electronic components mentioned in the previous paragraph, special parts are also used in the assembly of the Type 1121. These parts are manufactured or selected by Tektronix to satisfy particular requirements or are manufactured specially for Tektronix by other companies in accordance with Tektronix specifications. These parts and most mechanical parts should be ordered directly from Tektronix since they are normally difficult or impossible to obtain from other sources. All parts may be obtained either directly from the factory or through the local Tektronix Field Office.

Parts Ordering Information

Each part in the Type 1121 Preamplifier has a 6-digit Tektronix part number. This number and a description of the part will be found in the parts list. When ordering parts, be sure to include both the description of the part and the part number. For example, if the serial number of the Type 1121 is 000456, a certain resistor would be ordered as follows: R425, 6 K, 5 watt, fixed, wire-wound, 5%, part number 308-006, for Type 1121 Preamplifier, Serial Number 000456.

When parts are ordered in this manner, we are able to fill your orders promptly, and delays that might result from transposed numbers in the part number are avoided.

Since the production of your instrument, some of the parts may have been superseded by improved components. In such cases, the part numbers of these new components will not be listed in your Parts List. However, if you order a part from Tektronix and it has been superseded by an improved component, the new part will be shipped in place of the part ordered. Your local Tektronix Field Engineering Office has knowledge of these changes and may call you if a change in your purchase order is necessary.

Replacement information sometimes accompanies the improved components to aid in their installation.

TROUBLESHOOTING

This portion of the Operator's Manual provides troubleshooting information which can be used, when a trouble exists, to isolate the defective circuit or stage. Since this manual is intended for use both by operators and by main-

tenance personnel, the Troubleshooting information is planned to cover all common troubles likely to be encountered in both the Power Supply and Amplifier circuits of the Type 1121.

General Troubleshooting Procedure

Before attempting any troubleshooting work, you should carefully check all connections and controls for proper settings. If you are in doubt about control settings, you should review the Operating Information section of this Manual. When you have ascertained that a trouble does exist in the instrument, you can then proceed to isolate the defective circuit using the procedures outlined later in this section.

Often what appear to be troubles in the circuits will actually be the result of improper calibration of one or more circuits. One of the first troubleshooting steps should be to check the calibration of the suspected circuit. Complete calibration procedures are given in the Internal Adjustments portion of this manual.

When a trouble has been isolated to a definite circuit, inspect the circuit for loose or broken connections and components. Inspect to see if all tubes are lighted. Many troubles can be found most easily by visual means. Carefully perform a complete visual check of that circuit. Since there are several series-connected tubes in the circuit, failure of one tube may cause several others to appear inoperative. If a particular tube is found to be a source of trouble, be sure to return the good tubes to their original sockets. Don't depend on a tube tester to determine a tube's suitability for use in your instrument. The best criterion of a tube's suitability is its actual performance in the circuit.

Separate schematic diagrams for the amplifier and power supply circuits are contained in the Parts List and Schematic Diagrams Booklet used in conjunction with this manual. In addition, a Block Diagram found in the Theory of Operation section of the manual provides an overall picture of instrument operation. The reference designation of each electronic component of the instrument is shown on the circuit diagrams.

All wiring used in the Type 1121 Preamplifier is color coded to facilitate circuit tracing. In addition, primary power, filament and power-supply output leads are distinguished by specific color codes. All power-supply output leads follow the standard RETMA code. For example, the -150 -volt bus is coded brown-green-brown. The widest strip identifies the first color of the code.

The troubleshooting procedures that follow are divided into sections according to trouble symptoms. When trouble occurs in the instrument, the proper troubleshooting section can quickly be found by using the trouble symptoms.

Power Supply Troubles

When any malfunction of the Type 1121 occurs, it is a good idea to first check the power supply carefully, since a great deal of amplifier trouble stems directly from trouble in the Power Supply section. The first step in checking the Power Supply should be to check for proper supply voltages. A convenient place to do this is at the short ceramic terminal strip immediately above and to the rear of the turret attenuator on the amplifier deck. All supplies can be found at this strip. First, check the -150 -volt supply. Since this is the reference voltage supply, if it is off-tolerance or out of regulation, all other supplies will also be at improper

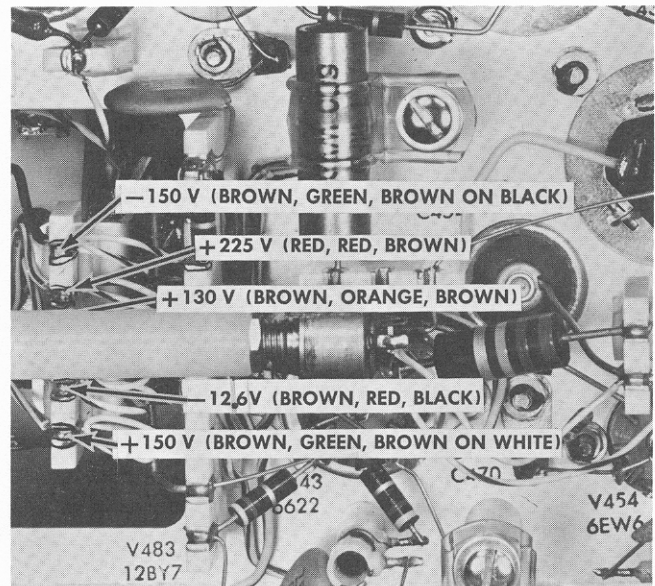

Fig. 4-1. Central location of Type 1121 regulated power supplies on Amplifier deck.

levels. When checking the values of regulated supply voltages, it is wise to check at the same time for ac ripple voltage, and for supply regulation. Full details of these procedures will be found in the Internal Adjustments Section of this manual.

Excessive Hum or Ripple voltages—display on oscilloscope will not hold stable position on screen

If the oscilloscope display of a waveform output from the Type 1121 tends to fluctuate up and down in vertical position, or if excessive hum or ripple voltages can be seen on the display, all voltage regulator tubes in the Power Supply should be checked. Check V647, V707 and V747, V624 and V684, V713 and voltage reference tube V609.

Burnout of Amplifier Tubes—or low emission as indicated by low gain

Check regulation of -12.6 volt heater supply.

No Output Voltage

If no output voltage is indicated from one or more of the regulated supplies, inspect for blackened or broken 10 ohm resistors in the rectifier sections of the power supply. If these are found, it will be advisable to check for other burned components, such as filter capacitors. These may also be an indication of other troubles such as short circuits in the supplies, or in the power transformer.

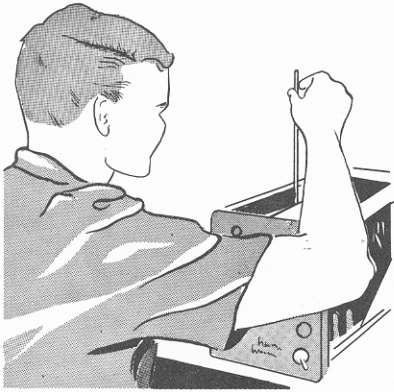

INTERNAL ADJUSTMENTS

Purpose

The procedures described in this portion of the Manual are designed to enable maintenance personnel to perform a complete recalibration of the Type 1121, paralleling as nearly as possible the factory calibration originally performed on the instrument prior to shipment. The complete calibration procedure requires the use of certain test equipment which might not be present except at complete maintenance facilities. However, there are certain steps in adjustment which can be performed by any operator having an accurate ac or dc voltmeter and a test oscilloscope. These steps will be noted in subsequent paragraphs. A partial calibration of your instrument will often improve its performance noticeably, especially after tube replacements. However, a complete calibration is necessary periodically to obtain the highest degree of dependability over a long period of time.

Check Power Supply Resistance

As a preliminary step to complete calibration of your Type 1121, and in any event after changing components or replacing circuit parts in the power supply, it is advisable to check the resistance of the various supplies to ground. This must be done with power off, and without the power cord plugged in. The -150 volt supply will measure about 4 K to ground, the -12.6 heater supply approximately $2.5\ \Omega$ and the $+130\text{ v}$, $+150\text{ v}$ and $+225\text{ v}$ somewhere between 30 K and 100 K . The resistance figures may vary considerably from one instrument to another, but it is important that they show enough resistance to preclude the possibility of a short-circuit in any particular supply. On the other hand, if any supply shows infinite resistance to ground, an open circuit is the obvious indication.

Set -150 v Adjust and Check Supply Voltage

Since the -150 volt supply is the reference voltage for all other supplies in the Type 1121, it is essential that this adjustable supply be accurately set before proceeding with calibration, whether you intend a complete, factory-type calibration or a partial "Tune-up" procedure. As the first step in voltage checking, plug in the power cord and turn POWER on. Allow time for circuit warmup, then connect an accurate dc voltmeter from the -150 volt supply to ground, and set R616, -150V ADJ. as nearly as possible to exactly -150 volts. It is extremely important that this control be set exactly, as the accuracy of all other power supplies de-

pends upon the setting of -150 volts. After setting -150 volts, check the values of the -12.6 volts and the $+130$ volts, $+150$ volts and $+225$ volts to see that their accuracy is within $\pm 2\%$ of indicated value.

Power Supply Ripple and Regulation

With the Type 1121 connected to 117 volts ac through a variac or some other adjustable voltage source, check the ripple voltage on each of the various power supplies by means of a test oscilloscope. When checking ripple, use a straight-through (X1) probe, properly grounded at one of the two reference ground points in the Type 1121 shown in Fig. 5-2. Use a high sensitivity plug-in unit such as Tektronix Type D or L or equivalent in test scope. Because of the extremely low value of ripple found on the Type 1121 power supplies, it is necessary that the test oscilloscope or the test-scope and plug-in preamplifier combination offer extremely high sensitivity. A good combination is a Tektronix 541, 543 or 545 oscilloscope equipped with a Type D or Type L plug-in unit or their equivalent, with the sensitivity set a maximum value. Sweep speed on the test oscilloscope should be set at 2 milliseconds per centimeter. You should read 120 -cycle ac ripple on the -150 volt supply at about $.2\text{ mv}$; on the -12.6 volt heater supply as about 4 mv ; on the $+225$ volt supply at $.2\text{ mv}$, and on the $+150$ volt supply at approximately 2 mv . While the probe is connected to each supply, vary line voltage with the variac between 105 and 130 volts to check regulation of the supplies. The -150 volt supply should regulate to a lower value of line voltage, somewhere between 95 and 100 volts.

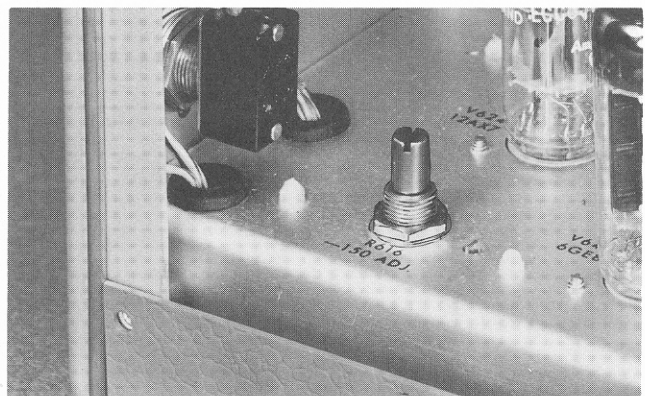

Fig. 5-1. R616, -150 Volt Adjust at right front of Power Supply Deck.

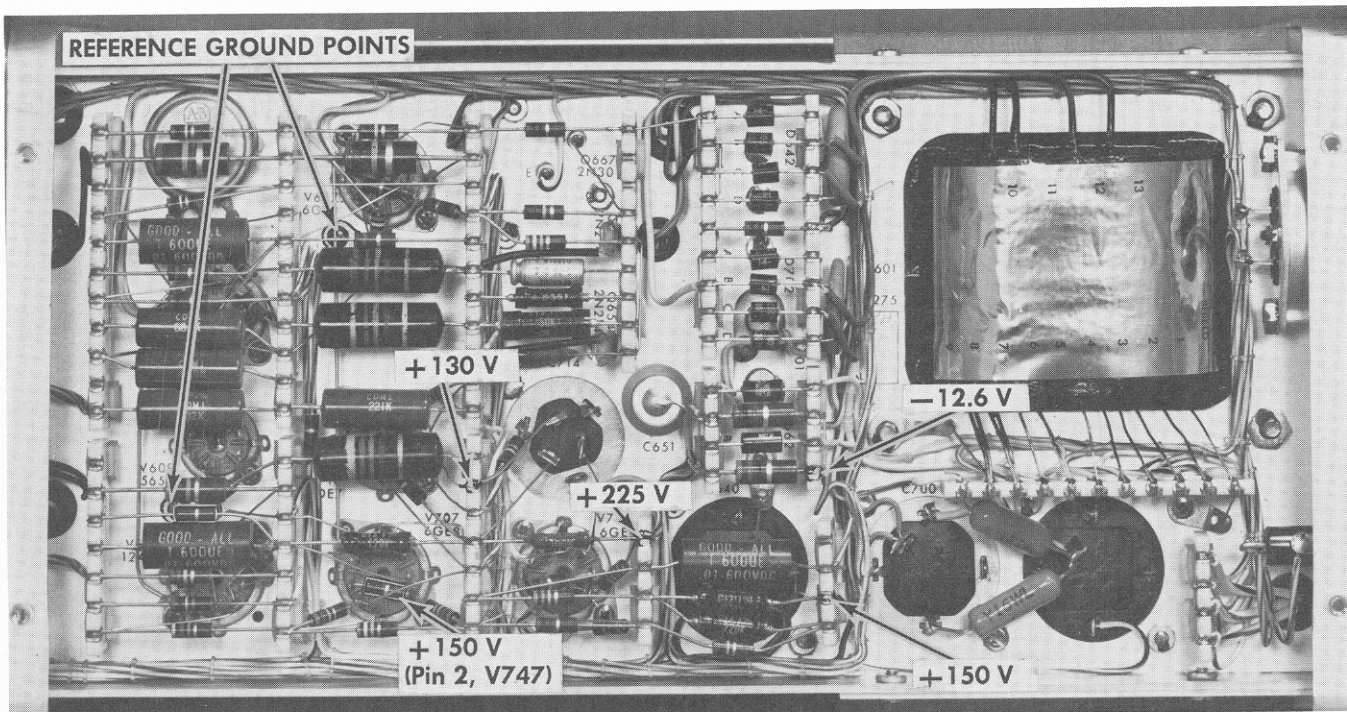

Fig. 5-2. Check points for Power Supply ripple and location of reference ground points on Power Supply Deck.

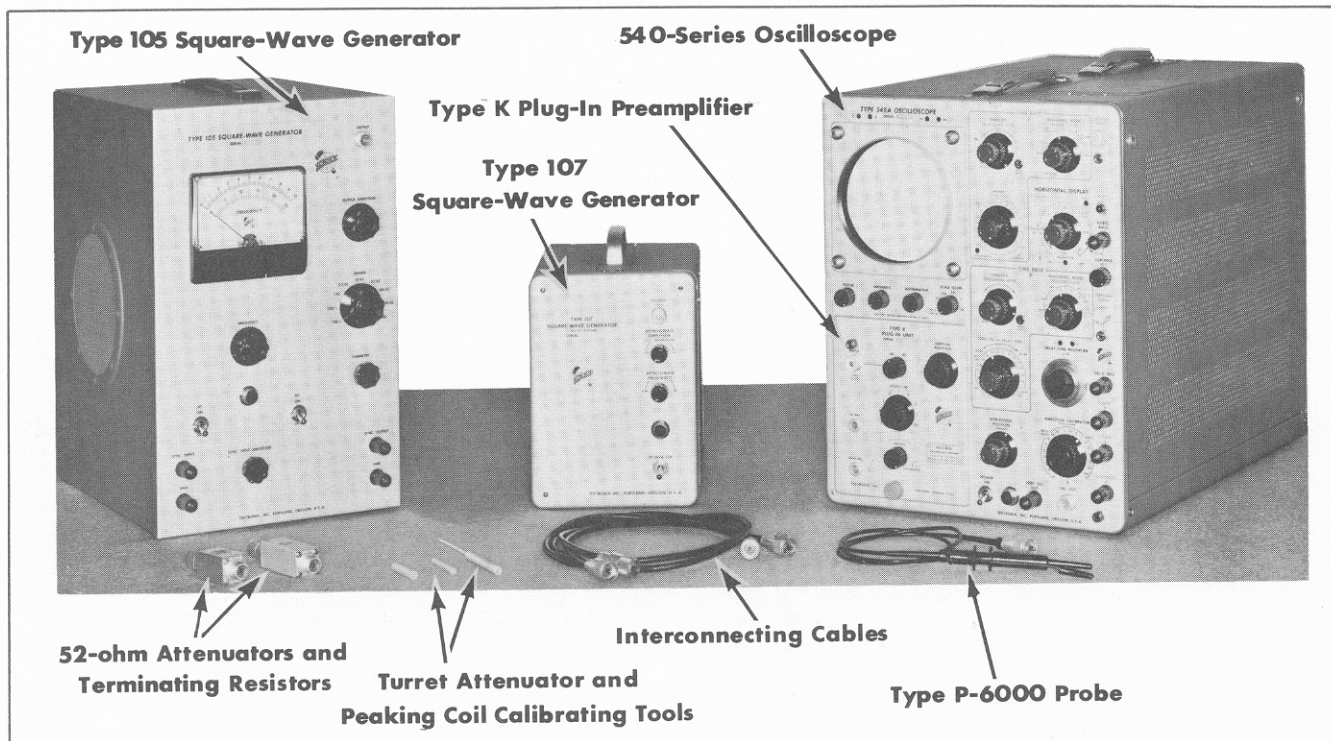

Fig. 5-3. Equipment required for complete calibration of Type 1121 Amplifier.

Check Hum, Noise and Microphonics

For the purpose of checking hum and noise level in the Type 1121, it is essential that the side and bottom panels be installed on the instrument. Short the INPUT connector of the Type 1121 by fastening an alligator clip from the center of the coax connector to the shield of the connector. Connect the output cable from the OUTPUT connector of the Type 1121 through a 93-ohm matching resistor to the input of the test oscilloscope. With the INPUT ATTENUATOR set

at the X1 position, output hum and noise as indicated on the test scope should not be more than 5 millivolts. Turn the attenuator to .20 and again read hum on the test scope. There should be no appreciable increase in noise or hum level at the lower attenuator setting. Check for microphonic indications by rapping gently on the front of the Type 1121. Microphonics should not be of the ringing type, and should not exceed about 50 microvolts at maximum gain setting. Excessive microphonics indicate the need for replacement of one or more tubes in the amplifier.

AMPLIFIER CALIBRATION

General Information

Before complete calibration of the Type 1121 preamplifier is attempted, certain basic test equipment is required. This includes:

1. Wide-band test oscilloscope—Tektronix Type 541, 543 or 545 or equivalent.

The test oscilloscope used should have a bandpass of approximately 30 mc. If Tektronix 540-series test scope is used, a Type K plug-in preamplifier is recommended. The preamplifier should have approximately 30-mc bandpass and deflection sensitivity of about .05 v/cm.

2. Tektronix Type 105 Square-Wave Generator or equivalent.

If a Type 105 is not available, a Square-Wave Generator having a continuously adjustable frequency range from 25 cycles to 1 mc and a rise time of .02 microseconds or better will be satisfactory.

3. Tektronix Type 107 Square-Wave Generator or equivalent.

If a Type 107 is not available, use a Square Wave Generator with a frequency range of 400 kc to 1 mc and rise time better than 3 μ sec.

4. 52-ohm and 93-ohm terminating resistors and 10:1 52-ohm 93-ohm attenuators.

Set DC Level Adjust

With bottom panel installed on the Type 1121, connect a dc voltmeter between ground and the OUTPUT connector of the Type 1121. By means of R473, OUTPUT DC LEVEL ADJ. set the voltage level to zero.

Set Low Frequency Response Compensation

Be sure the bottom and left-side panels are installed on the Type 1121. Connect the Type 1121 output cable into a B-93-R 93-ohm terminating resistor and a Tektronix Type 541, 543 or 545 oscilloscope containing a Type K plug-in unit. Set controls of the "K" Unit as follows:

VOLTS/CM	.5
AC-DC	DC
VARIABLE	CALIBRATED

Oscilloscope controls:

TRIGGERING MODE	AUTOMATIC
TRIGGER SLOPE	+INT.
HORIZONTAL DISPLAY	NORM
TIME/CM	10 MILLISEC

Type 105:

FREQUENCY	50 CYCLES
-----------	-----------

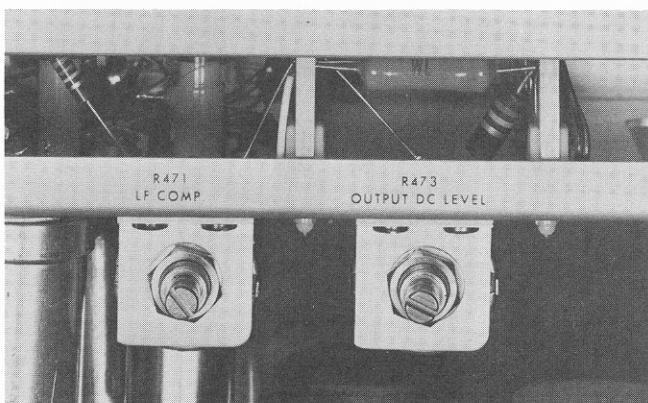

Fig. 5-4. Location of DC Level Adjust and Low Frequency Response Compensation on under side of Amplifier Deck.

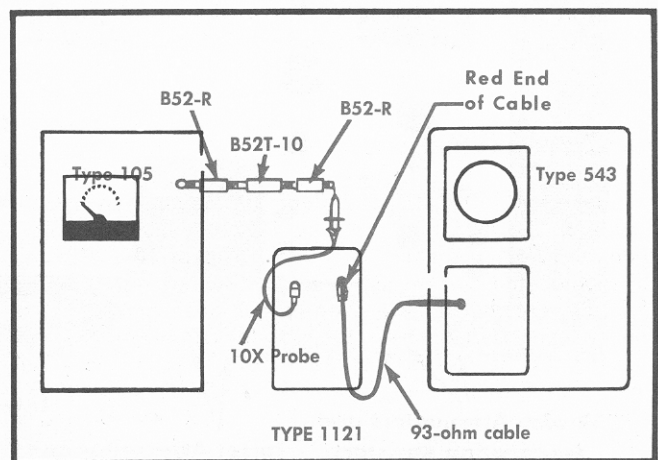

Fig. 5-5. Type 105, Type 1121 and Oscilloscope connections for setting Low Frequency compensation.

Internal Adjustment — Type 1121

At the Type 105 OUTPUT, connect a 52-ohm terminating resistor, a 10:1 52-ohm "T" pad attenuator and another 52-ohm terminating resistor. The importance of this combination is to insure that the input to the Type 1121 can be limited to 20 millivolts, ± 10 mv. From the INPUT connector of the Type 1121, connect a X10 probe. Set the INPUT ATTENUATOR of the Type 121A to X1. With the probe inserted into the terminating combination from the OUTPUT of the Type 105, set the square-wave presentation on the test scope for a flat square-wave by adjusting R471, L.F. COMP. in the Type 1121.

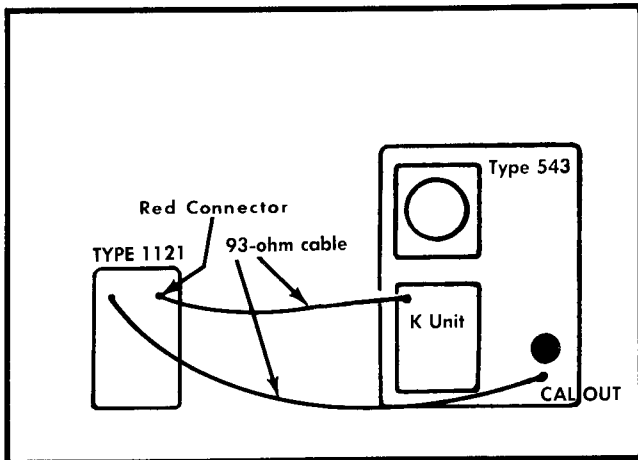

Fig. 5-6. Type 1121 and Oscilloscope connections for adjusting gain.

Set Gain

Leave the Type 1121, K Unit and Test Scope triggering and display settings as in the preceding step. Connect a 93-ohm cable from the CAL. OUT connector of the test scope to the INPUT of the Type 1121. Set the test scope AMPLITUDE CALIBRATOR for 10 mv. Set the GAIN ADJ. control on the Type 1121 front panel for 2 centimeters of deflection on the test scope screen. Before making final adjustments, turn the GAIN ADJ. control wide open to be sure there is at least 10% additional range of gain on the control.

Set Transient Response

Connect the OUTPUT of a Type 107 Square-Wave Generator to the INPUT of the Type 1121 through a combination of 52-ohm terminating resistor, 52-ohm 10:1 "T" pad attenuator and 52-ohm terminating resistor as shown in Fig. 5-7. Be sure that the matching resistor-attenuator combination is connected at the Type 1121 INPUT end of the connection, as the OUTPUT of the Type 107 is internally terminated. Connect the Type 1121 OUTPUT to the "K" Unit on the test scope through a 93-ohm cable terminated at the scope input end by a 93-ohm 10:1 "L" pad. Set Type 107 APPROXIMATE FREQUENCY to 500 kc. Set APPROXIMATE AMPLITUDE to minimum (CCW). The "K" Unit VOLTS/CM should be set to .05.

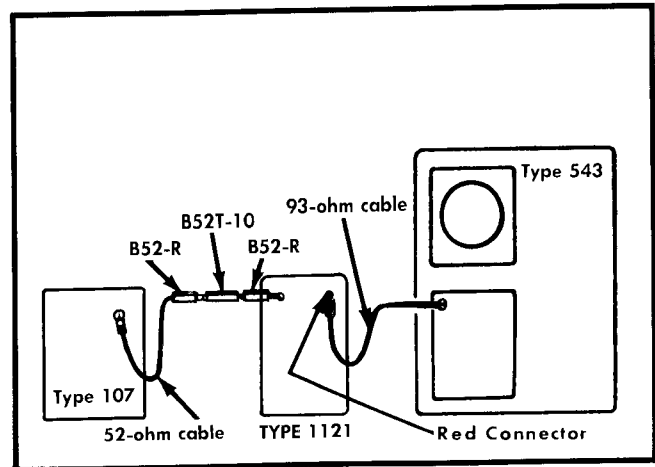

Fig. 5-7. Type 107, Type 1121 and Oscilloscope connections for setting Transient Response.

With the Type 1121 VOLTAGE GAIN set the 100, adjust for a square corner on the test scope waveform presentation by tuning peaking coils L433, L434, L463 and L475. This is best accomplished by first pre-setting the tuning slugs at the very bottom of the coil forms, and adjusting by gradually raising them to the point where proper peaking is achieved.

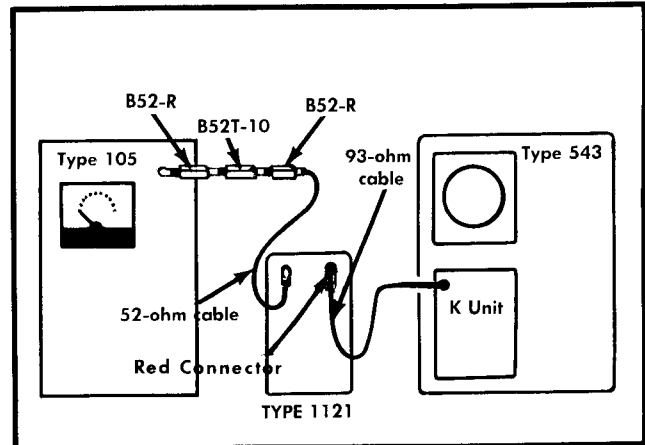

Fig. 5-8. Type 105, Type 1121 and Oscilloscope connections for setting Attenuator Series Compensation.

Set Attenuator Series Compensation

Connect a 1 kc square-wave output from the Type 105 properly terminated to the INPUT of the Type 1121. With the test scope TIME/CM set at 2 MILLISEC, set Type 1121 INPUT ATTENUATOR to X2, and using an insulated tool, adjust SERIE COMPENSATION ADJUST on the Type 1121 front panel for a flattop squarewave presentation. Follow the same procedure on each attenuator step from X2 through X500. It will be necessary to reduce the amount of attenuation between Type 105 and Type 1121 on the lower attenuator settings in order to maintain sufficient scope deflection to see the display.

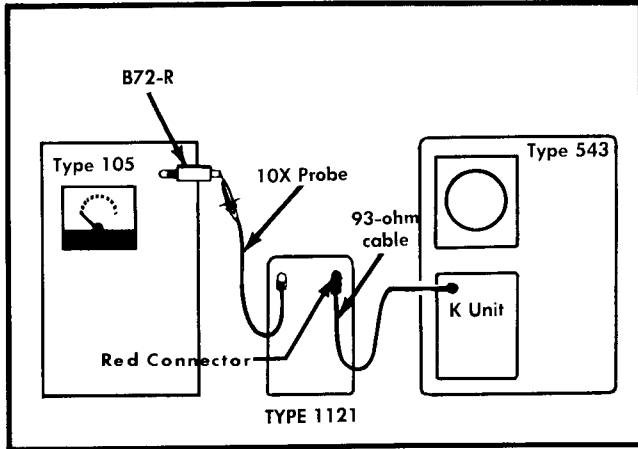

Fig. 5-9. Type 105, Type 1121 and Oscilloscope connections for setting Attenuator Shunt Compensation.

Set Attenuator Shunt Compensation

Leaving other control settings as in the previous calibration step, terminate the Type 105 OUTPUT with a 52-ohm resistor. Insert a X10 probe between Type 105 OUTPUT and Type 1121 INPUT. Set INPUT ATTENUATOR of the Type 1121 to X1, and compensate the probe so that the square-wave presentation on the test scope shows a flat top. This insures that the probe is properly compensated for the input capacitance of the Type 1121. Now, turn the INPUT ATTENUATOR on the Type 1121 to X2, and without making further adjustments of the probe, adjust the input capacitance of the Type 1121 to match the probe by means of the front-panel SHUNT COMPENSATION ADJ. Follow this same procedure for all INPUT ATTENUATOR steps through .20.

PARTS LIST *and*

DIAGRAMS

(Faint parts list table with columns for part numbers, descriptions, and quantities)

Cer.
Comp.
EMC
f
G
GMV
h
K or k
M/Cer.
M or meg
 μ
 $\mu\mu$
m

Ceramic
Composition
Electrolytic, metal cased
Farad
Giga, or 10^9
Guaranteed minimum value
Henry
Kilohms or kilo (10^3)
Mica or Ceramic
Megohms or mega (10^6)
Micro, or 10^{-6}
Micromicro or 10^{-12}
milli or 10^{-3}

ABBREVIATIONS

n
 Ω
p
PTB
PMC
Poly.
Prec.
PT
T
v
Var.
w
WW

Nano or 10^{-9}
ohm
Pico or 10^{-12}
Paper, "Bathtub"
Paper, metal cased
Polystyrene
Precision
Paper Tubular
Terra or 10^{12}
Working volts DC
Variable
Watt
Wire-wound

SPECIAL NOTES AND SYMBOLS

+ and up
† Approximate serial number.
X000 Part first added at this serial number.
000X Part removed after this serial number.
*000-000 Asterisk preceding Tektronix Part Number indicates manufactured by or for Tektronix, also reworked or checked components.
(Mod. w/) Simple replacement not recommended.
Modify to value for later instruments and change other parts to match.



MANUFACTURERS OF CATHODE-RAY OSCILLOSCOPES

HOW TO ORDER PARTS

Replacement parts may be purchased at current net prices from your local Tektronix Field Office or from the factory. Most of the parts can be obtained locally. All of the structural parts, and those parts noted in the parts list "Manufactured by Tektronix", should be ordered from Tektronix.

When ordering from Tektronix include a complete description of the part, and its 6-digit part number. Give the type, serial number, and modification number (if any) of the instrument for which it is ordered.

If the part which you have ordered has been replaced by a new or improved part, the new part will be shipped instead. Tektronix Field Engineers are informed of such changes. Where necessary replacement information comes with new parts.

PARTS LIST

INPUT ATTENUATOR

Capacitors

							Tektronix Part Number
C408B				Adjusting Slug			214-084
C408D		12 $\mu\mu\text{f}$	Cer.	Fixed	500 v	$\pm 0.6 \mu\mu\text{f}$	281-508
C408C				Adjusting Slug			214-084
C409A		4.7 μf	Cer.	Fixed	500 v	$\pm 1 \mu\mu\text{f}$	281-501
C409B				Adjusting Slug			214-084
C409C				Adjusting Slug			214-084
C410A		4.7 μf	Cer.	Fixed	500 v	$\pm 1 \mu\mu\text{f}$	281-501
C410B				Adjusting Slug			214-084
C410C				Adjusting Slug			214-084
C410E		12 $\mu\mu\text{f}$	Cer.	Fixed	500 v	$\pm 0.6 \mu\mu\text{f}$	281-508
C411A		4.7 μf	Cer.	Fixed	500 v	$\pm 1 \mu\mu\text{f}$	281-501
C411B				Adjusting Slug			214-084
C411C				Adjusting Slug			214-084
C411E		47 $\mu\mu\text{f}$	Cer.	Fixed	500 v	$\pm 4.7 \mu\mu\text{f}$	281-519
C412A		4.7 μf	Cer.	Fixed	500 v	$\pm 1 \mu\mu\text{f}$	281-501
C412B				Adjusting Slug			214-084
C412C				Adjusting Slug			214-084
C412E		100 $\mu\mu\text{f}$	Cer.	Fixed	500 v	$\pm 10 \mu\mu\text{f}$	281-530
C413A	101-209	6.8 $\mu\mu\text{f}$	Cer.	Fixed	500 v	$\pm 10\%$	281-541
C413A	210-up	4.7 $\mu\mu\text{f}$	Cer.	Fixed	500 v		281-501
C413B				Adjusting Slug			214-084
C413C				Adjusting Slug			214-084
C413E		200 $\mu\mu\text{f}$	Mica	Fixed	500 v	10%	283-557
C414A	101-209	6.8 $\mu\mu\text{f}$	Cer.	Fixed	500 v	$\pm 10\%$	281-541
C414A	210-up	4.7 $\mu\mu\text{f}$	Cer.	Fixed	500 v		281-501
C414B				Adjusting Slug			214-084
C414C				Adjusting Slug			214-084
C414E		400 $\mu\mu\text{f}$	Mica	Fixed	500 v	10%	283-556
C415A	101-180	6.8 $\mu\mu\text{f}$	Cer.	Fixed	500 v	10%	281-541
C415A	181-up	6.8 $\mu\mu\text{f}$	Cer.	Fixed	500 v		281-572
C415B				Adjusting Slug			214-084
C415C				Adjusting Slug			214-084
C415E		625 $\mu\mu\text{f}$	Mica	Fixed	500 v	$\pm 10\%$	283-547

Resistors

R408C		500 k	$\frac{1}{2}$ w	Fixed	Prec.	1%	309-140
R408E		1 Meg	$\frac{1}{8}$ w	Fixed	Prec.	1%	318-004
R409C		800 k	$\frac{1}{2}$ w	Fixed	Prec.	1%	309-288
R409E		250 k	$\frac{1}{8}$ w	Fixed	Prec.	1%	318-032
R410C		900 k	$\frac{1}{2}$ w	Fixed	Prec.	1%	309-142
R410E		111 k	$\frac{1}{8}$ w	Fixed	Prec.	1%	318-006
R411C		950 k	$\frac{1}{2}$ w	Fixed	Prec.	1%	309-143
R411E		52.6 k	$\frac{1}{8}$ w	Fixed	Prec.	1%	318-007
R412C		980 k	$\frac{1}{2}$ w	Fixed	Prec.	1%	309-277
R412E		20.4 k	$\frac{1}{8}$ w	Fixed	Prec.	1%	318-033

Resistors (continued)

							Tektronix Part Number
R413C		990 k	1/2 w	Fixed	Prec.	1%	309-145
R413E		10.1 k	1/8 w	Fixed	Prec.	1%	318-009
R414C		995 k	1/2 w	Fixed	Prec.	1%	309-146
R414E		5.03 k	1/8 w	Fixed	Prec.	1%	318-010
R415C		998 k	1/2 w	Fixed	Prec.	1%	309-278
R415E		2 k	1/8 w	Fixed	Prec.	1%	318-034

PREAMPLIFIER

Capacitors

C400		.1 μ f	PTM	Fixed	600 v		285-556
C424		1000 μ f	EMT	Fixed	6 v		290-093
C430		3 x 20 μ f	EMC	Fixed	350 v		290-115
C445	101-180	.1 μ f	MT	Fixed	600 v		285-547
C445	181-up	.1 μ f	MT	Fixed	600 v		285-587
C454		1000 μ f	EMT	Fixed	6 v		290-093
C460		3 x 20 μ f	EMC	Fixed	350 v		290-115
C470	101-180	.1 μ f	MT	Fixed	600 v		285-547
C470	181-up	.1 μ f	MT	Fixed	600 v		285-587
C477		3 x 20 μ f	EMC	Fixed	350 v		290-115
C483		.02 μ f	Cer.	Fixed	600 v		283-006
C487		.02 μ f	Cer.	Fixed	600 v		283-006
C492		.02 μ f	Cer.	Fixed	150 v		283-004
C493		.02 μ f	Cer.	Fixed	150 v		283-004
C494		.02 μ f	Cer.	Fixed	150 v		283-004
C601		1 μ f	PMC	Fixed	600 v		285-553
C610		.022 μ f	PTM	Fixed	600 v		285-517
C617		.047 μ f	PTM	Fixed	400 v		285-519
C628		.01 μ f	PTM	Fixed	600 v		285-511
C640		160 x 10 μ f	EMC	Fixed	350 v		290-060
C642		.02 μ f	Cer.	Fixed	1400 v		283-022
C650		5 μ f	EMT	Fixed	25 v		290-026
C651		100 μ f	EMT	Fixed	25 v		290-015
C654		.1 μ f	Cer.	Fixed	50 v		283-009
C660		2000 μ f	EMC	Fixed	30 v		290-087
C680		.047 μ f	PTM	Fixed	400 v		285-519
C688		.01 μ f	PTM	Fixed	600 v		285-511
C700		80 μ f	EMC	Fixed	500 v		290-058
C702		.02 μ f	Cer.	Fixed	1400 v		283-022
C714		3 x 10 μ f	EMC	Fixed	350 v		290-032
C730		.01 μ f	PTM	Fixed	600 v		285-511

Fuse

F601	1.6a	3AG Slo-Blo		for 117-v operation	159-034
	.8a	3AG Slo-Blo		for 234-v operation	159-018

Inductors

L433		10-15 μ h		Var.	*114-126
L434		1.45-2.9 μ h		Var.	*114-127
L463		14-29 μ h		Var.	*114-130
L470		3.4 μ h		Fixed	*108-186
L475		2.7-5.4 μ h		Var.	*114-091
LR431		1.4 μ h		Fixed	*114-130
LR462		3.2 μ h		Fixed	*108-184

Resistors

Tektronix
Part Number

R420	1 M	1/2 w	Fixed	Prec.	1%	309-014
R421	100 Ω	1/2 w	Fixed	Comp.	10%	302-101
R424	8 k	5 w	Fixed	WW	5%	308-053
R425	6 k	5 w	Fixed	WW	5%	308-052
R427	100 k	1/2 w	Fixed	Prec.	1%	309-045
R428	60 k	1/2 w	Fixed	Prec.	1%	309-041
R429	47 Ω	1/2 w	Fixed	Comp.	10%	302-470
R430	5.5 k	5 w	Fixed	WW	5%	308-101
R433	1.2 k	2 w	Fixed	Mica Plate	1%	*310-565
R440	2.2 M	1/2 w	Fixed	Comp.	10%	302-225
R442	1 k	1/2 w	Fixed	Comp.	10%	302-102
R444	56 k	1 w	Fixed	Comp.	10%	304-563
R445	47 Ω	1/2 w	Fixed	Comp.	10%	302-470
R447	1.5 k	1/2 w	Fixed	Comp.	10%	302-152
R448	18 k	2 w	Fixed	Comp.	10%	306-183
R451	47 Ω	1/2 w	Fixed	Comp.	10%	302-470
R454	5.5 k	5 w	Fixed	WW	5%	308-101
R455	5.5 k	5 w	Fixed	WW	5%	308-101
R456	100 Ω	1/2 w	Var.	Comp.	20%	311-169
R457	1 k	1/2 w	Fixed	Comp.	10%	302-102
R460	10 k	5 w	Fixed	WW	5%	308-054
R463	1.8 k	1/2 w	Fixed	Mica Plate	1%	*310-533
R470	330 k	1/2 w	Fixed	Comp.	10%	302-334
R471	2 M		Var.	Comp.		311-042
R472	1 k	1/2 w	Fixed	Comp.	10%	302-102
R473	2 k		Var.	Comp.		311-008
R474	56 k	1 w	Fixed	Comp.	10%	304-563
R475	47 Ω	1/2 w	Fixed	Comp.	10%	302-470
R477	1.5 k	1/2 w	Fixed	Comp.	10%	302-152
R478	22 k	2 w	Fixed	Comp.	10%	306-223
R481	47 Ω	1/2 w	Fixed	Comp.	10%	302-470
R482	47 Ω	1/2 w	Fixed	Comp.	10%	302-470
R483	47 Ω	1/2 w	Fixed	Comp.	10%	302-470
R484	2.5 k	5 w	Fixed	WW	5%	308-127
R485	2 k	5 w	Fixed	WW	5%	308-091
R486	30 Ω	1/2 w	Fixed	Comp.	5%	301-300
R487	47 Ω	1/2 w	Fixed	Comp.	10%	302-470
R494	16 Ω	5 w	Fixed	WW	5%	308-166
R609	33 k	1/2 w	Fixed	Comp.	10%	302-333
R610	100 k	1/2 w	Fixed	Comp.	10%	302-104
R615	68.1 k	1 w	Fixed	Prec.	1%	310-117
R616	10 k		Var.	Comp		311-016
R617	49.9 k	1 w	Fixed	Prec.	1%	310-116
R618	470 k	1/2 w	Fixed	Comp.	10%	302-474
R621	1 k	1/2 w	Fixed	Comp.	10%	302-102
R623	1 M	1/2 w	Fixed	Comp.	10%	302-105
R625	100 k	1/2 w	Fixed	Comp.	10%	302-104
R628	2.7 M	1/2 w	Fixed	Comp.	10%	302-275
R629	2.7 M	1/2 w	Fixed	Comp.	10%	302-275
R633	1.2 M	1/2 w	Fixed	Comp.	10%	302-125

Resistors (continued)

							Tektronix Part Number
R635		15 k	2 w	Fixed	Comp.	10%	306-153
R636		15 k	2 w	Fixed	Comp.	10%	306-153
R637		220 k	1/2 w	Fixed	Comp.	10%	302-224
R638		39 k	1/2 w	Fixed	Comp.	10%	302-393
R639		100 k	1/2 w	Fixed	Comp.	10%	302-104
R640		10 Ω	1/2 w	Fixed	Comp.	10%	302-100
R643		1 k	1/2 w	Fixed	Comp.	10%	302-102
R647		2 k	10 w	Fixed	WW	5%	308-017
R650		4.535 k	1/2 w	Fixed	Prec.	1%	309-191
R651		50 k	1 w	Fixed	Prec.	1%	310-086
R654	101-299	390 k	1/2 w	Fixed	Comp.	10%	302-394
R654	300-up	150 k	1/2 w	Fixed	Comp.	10%	302-154
R660		.05 Ω	5 w	Fixed	WW	5%	308-165
R664		220 k	1/2 w	Fixed	Comp.	10%	302-224
R667		10 Ω	8 w	Fixed	WW	5%	308-167
R673		680 k	1/2 w	Fixed	Comp.	10%	302-684
R680		332 k	1 w	Fixed	Prec.	1%	310-119
R681		221 k	1 w	Fixed	Prec.	1%	310-118
R682		1 M	1/2 w	Fixed	Comp.	10%	302-105
R683		1 k	1/2 w	Fixed	Comp.	10%	302-102
R685		82 k	1 w	Fixed	Comp.	10%	304-823
R686		180 k	1/2 w	Fixed	Comp.	10%	302-184
R688		1.5 M	1/2 w	Fixed	Comp.	10%	302-155
R689		2.2 M	1/2 w	Fixed	Comp.	10%	302-225
R697		390 k	1/2 w	Fixed	Comp.	10%	302-394
R698		680 k	1/2 w	Fixed	Comp.	10%	302-684
R699		47 k	1/2 w	Fixed	Comp.	10%	302-473
R700		10 Ω	1/2 w	Fixed	Comp.	10%	302-100
R703		1 k	1/2 w	Fixed	Comp.	10%	302-102
R707		6 k	10 w	Fixed	WW	5%	308-124
R710		100 k	1/2 w	Fixed	Comp.	5%	301-104
R712		110 k	1/2 w	Fixed	Comp.	5%	301-114
R714		220 k	1/2 w	Fixed	Comp.	10%	302-224
R717		82 Ω	1 w	Fixed	Comp.	10%	304-820
R718		82 Ω	1 w	Fixed	Comp.	10%	304-820
R720		106 k	1/2 w	Fixed	Comp.	1%	309-161
R721		120 k	1/2 w	Fixed	Prec.	1%	309-091
R722		100 Ω	1/2 w	Fixed	Comp.	10%	302-101
R730		154 k	1/2 w	Fixed	Prec.	1%	309-234
R731		150 k	1/2 w	Fixed	Prec.	1%	309-049
R732		330 k	1/2 w	Fixed	Comp.	10%	302-334
R733		1 k	1/2 w	Fixed	Comp.	10%	302-102
R734		470 k	1/2 w	Fixed	Comp.	10%	302-474
R737		1.2 M	1/2 w	Fixed	Comp.	10%	302-125
R738		100 k	1/2 w	Fixed	Comp.	10%	302-104
R739		47 k	1/2 w	Fixed	Comp.	10%	302-473
R743		1 k	1/2 w	Fixed	Comp.	10%	302-102
R747		15 k	10 w	Fixed	WW	5%	308-024

Switches

			Wired	Unwired
SW410 †		INPUT ATTENUATOR	263-002	
SW601		POWER ON		*260-134
TK601		THERMO CUTOUT 128°		260-070

Transformers

T601		POWER		*120-145
------	--	-------	--	----------

Diodes

D422		T12G Diode, Germanium		152-008
D452		T12G Diode, Germanium		152-008
D642	101-310	Silicon Diode		152-011
D642	311-up	Silicon Diode		152-047
D662	101-150	Silicon Diode		152-009
D662	151-310	Silicon Diode		**152-011
D662	311-up	Silicon Diode		152-035
D702	101-310	Silicon Diode		152-011
D702	311-up	Silicon Diode		152-047

Transistors

Q654		2N214		151-004
Q664		2N214		151-004
Q667		2N301		151-001

Electron Tubes

V424		6922 Selected		*157-060
V443		6922		154-195
V454		6EW6		154-212
V483		12BY7		154-047
V609		5651		154-052
V624		12AX7		154-043
V647		6GE8		154-260
V684		12AX7		154-043
V707		6GE8		154-260
V713		6DE7		154-188
V747		6GE8		154-260

† We strongly recommend replacement of this switch as a unit by part number 263-002. However, if individual parts are to be replaced, refer to separate Input Attenuator listing for part numbers and descriptions.

** Circuit designed for 100 PIV, 500 MA.

IX



2X

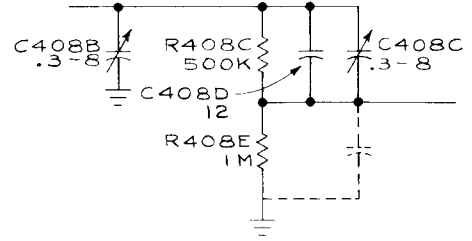

20X

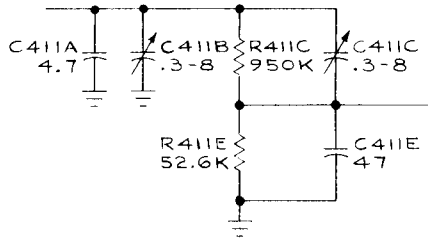

50X

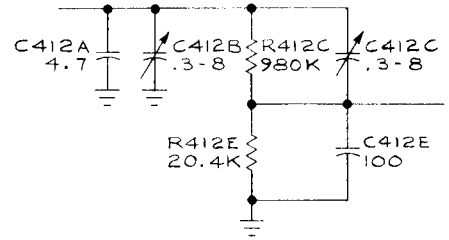

500X

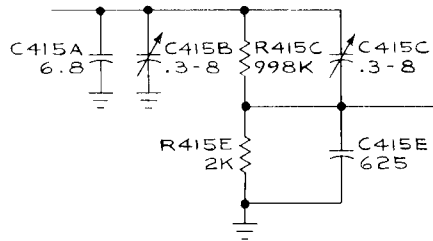

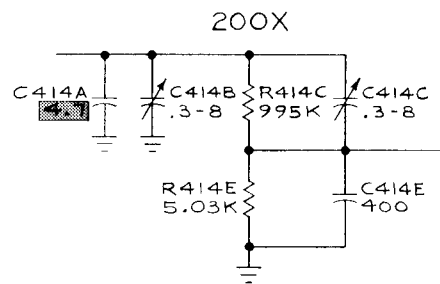
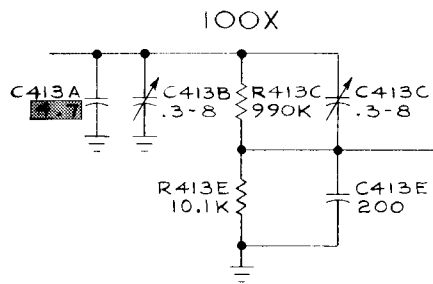
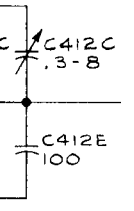
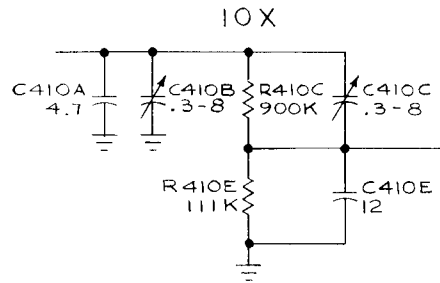
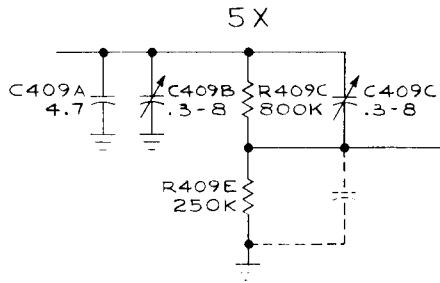
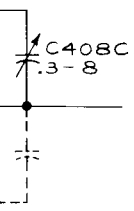

SEE PARTS LIST FOR EARLIER
VALUES AND S/N CHANGES
OF PARTS MARKED

B₁

MRH
6-21-60
TURRET ATTENUATOR

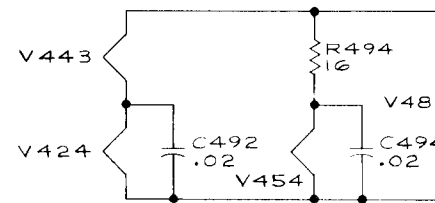
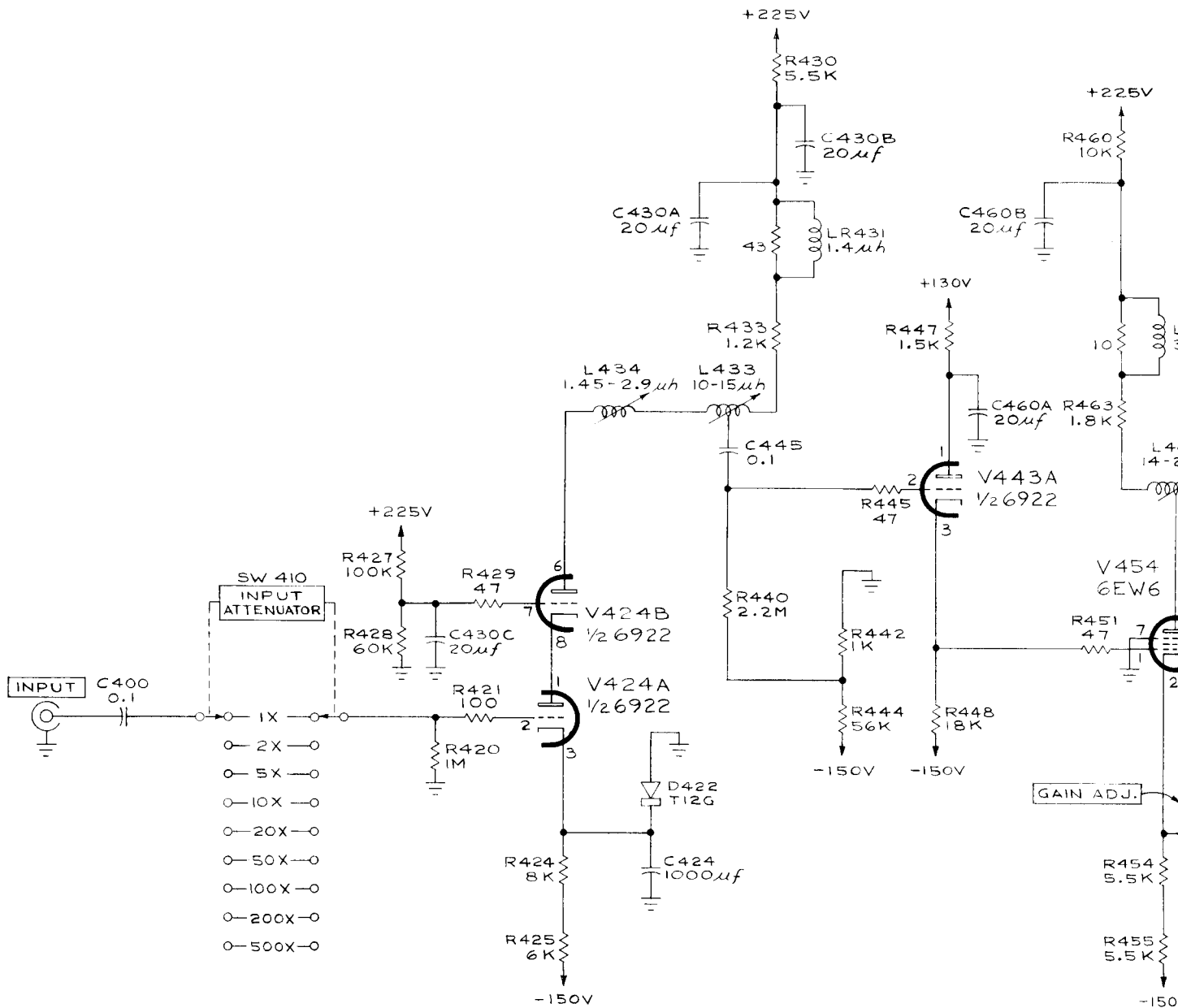

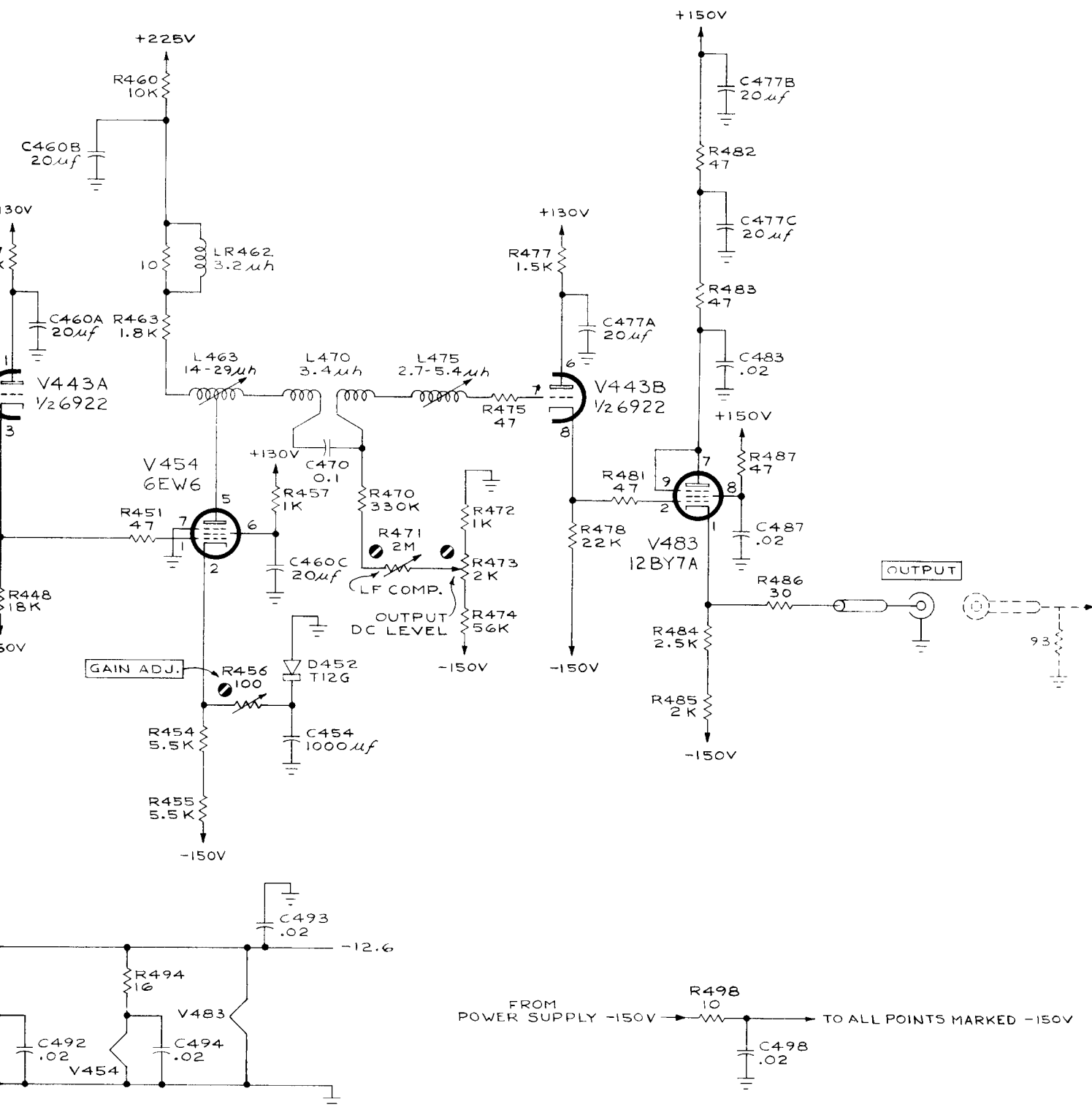

A₁

MR4
12-3-59
AMPLIFIER

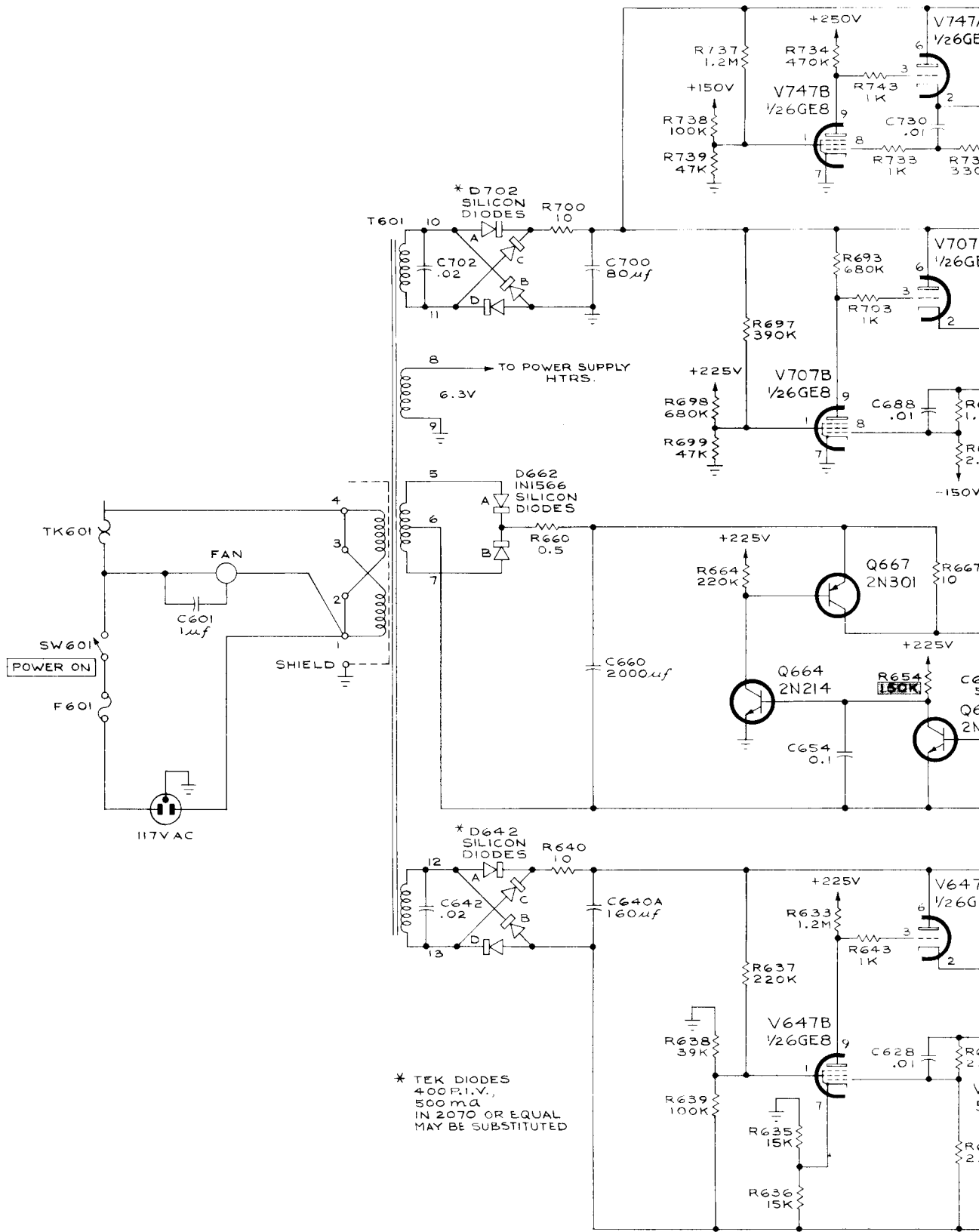

TYPE 1121

B

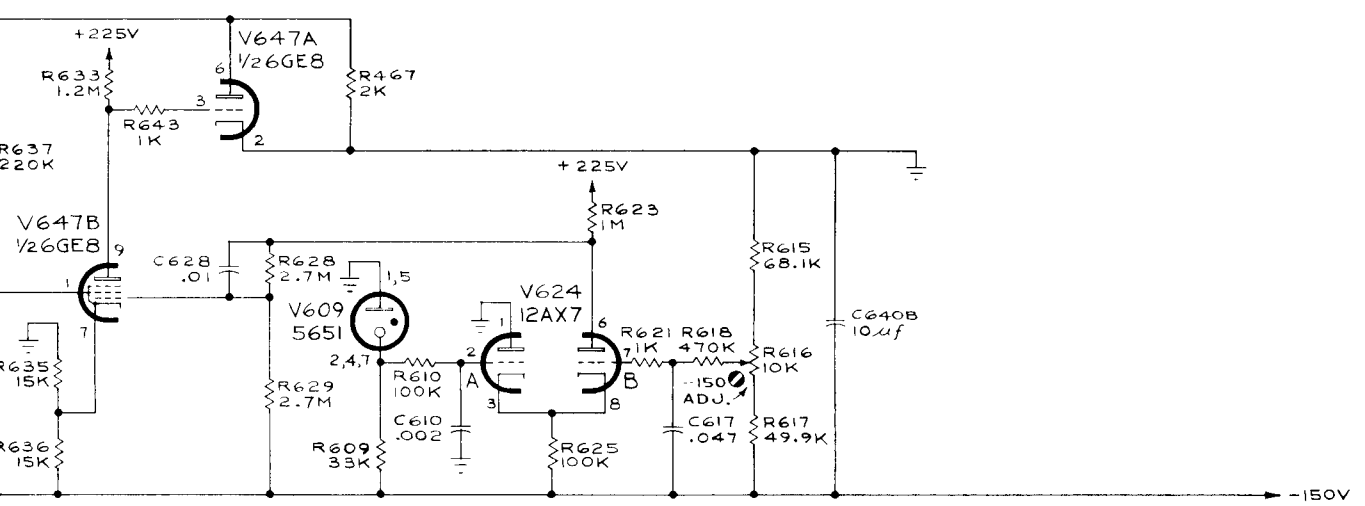
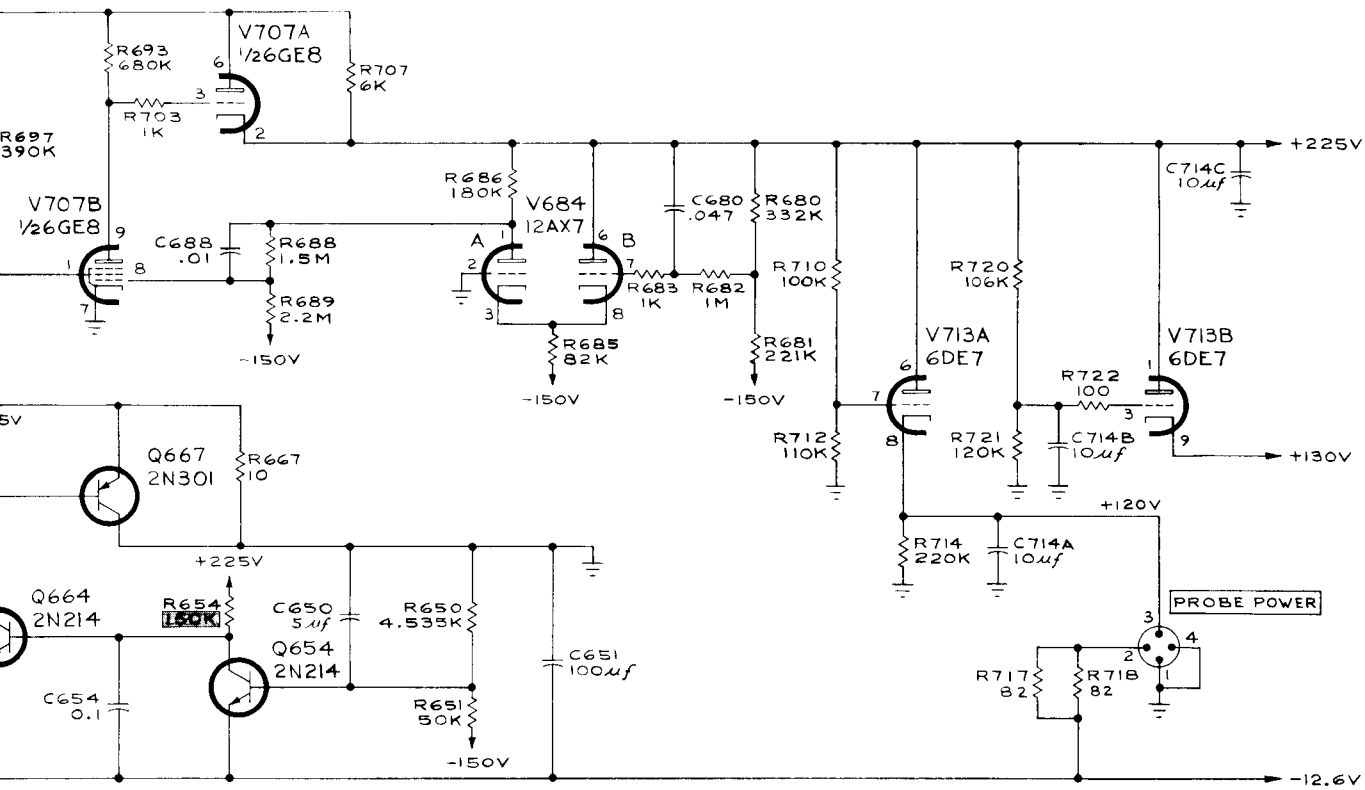
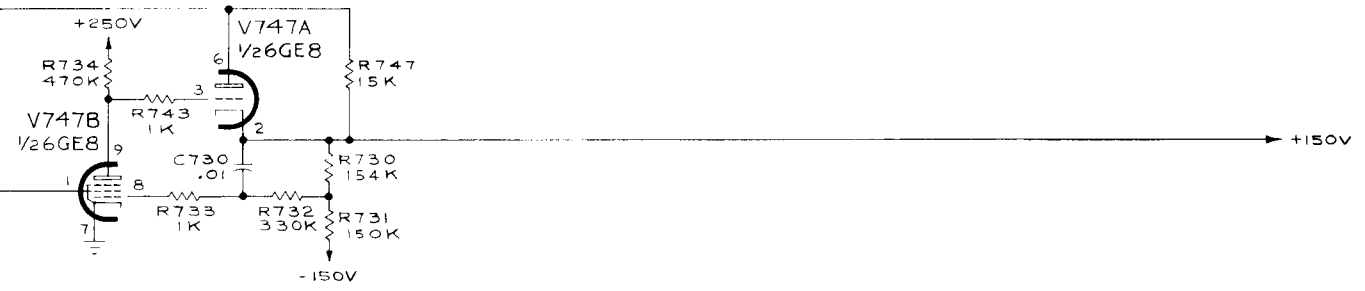

SEE PARTS LIST FOR EARLIER
VALUES AND S/N CHANGES
OF PARTS MARKED

MRH
3-27-61
POWER SUPPLY